

brownian movement

1

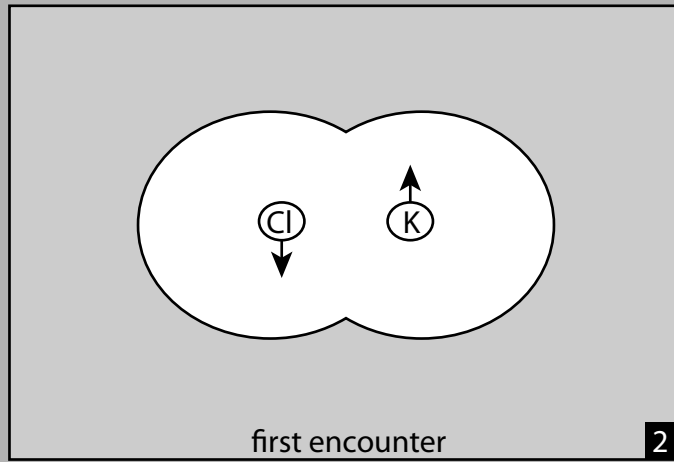

first encounter

2

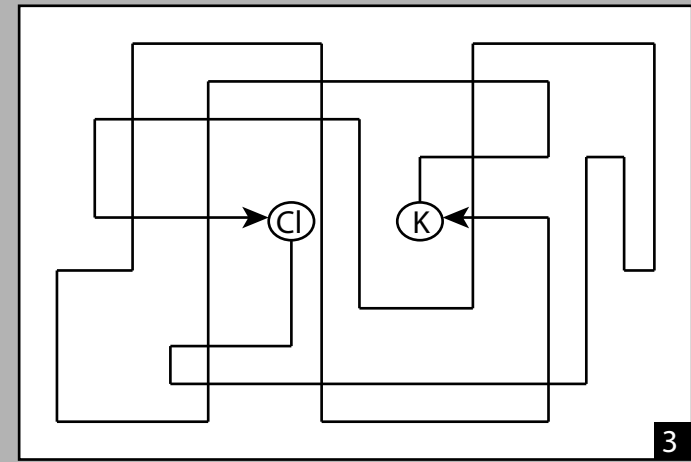

rat race

3

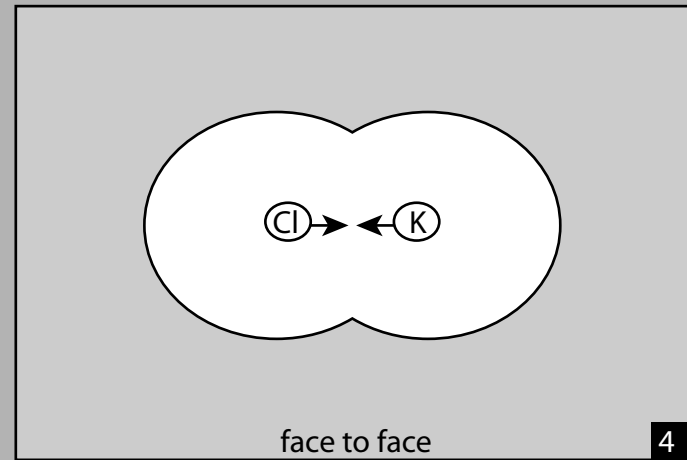

face to face

4

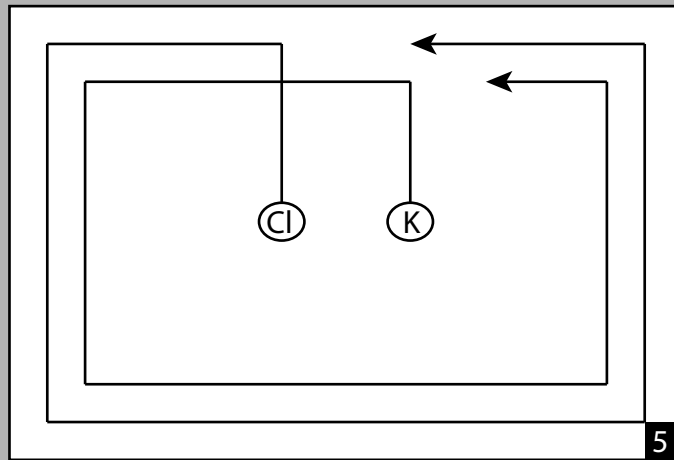

performance circuit

5

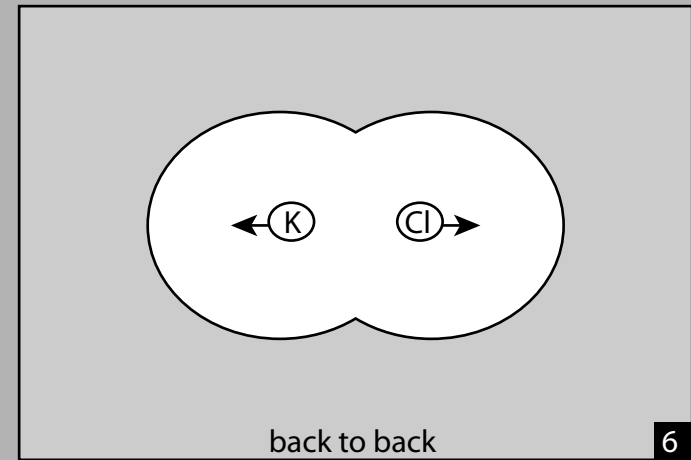

back to back

6

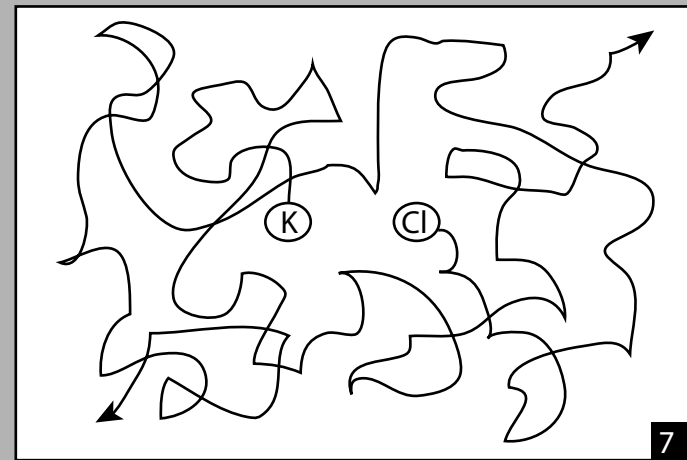

night club

7

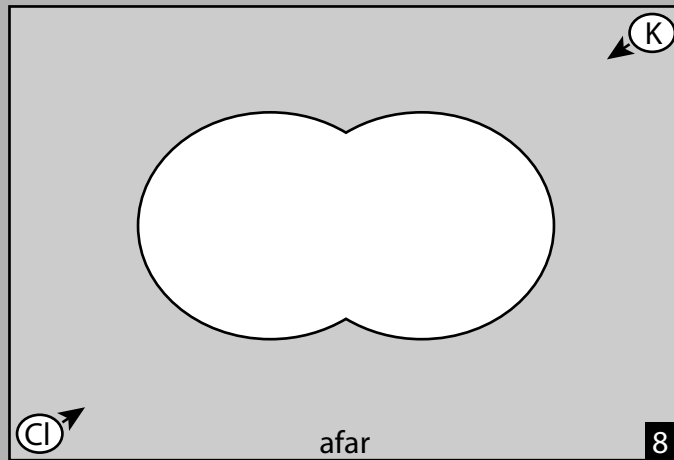

afar

8

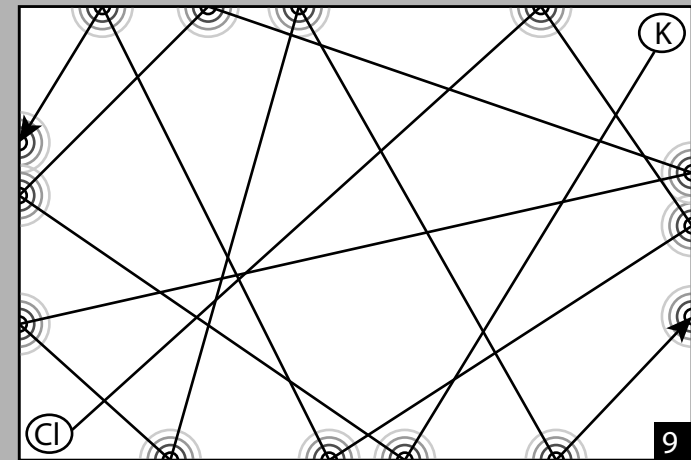

video game

9